

ZETA 40P / ZETA 85P

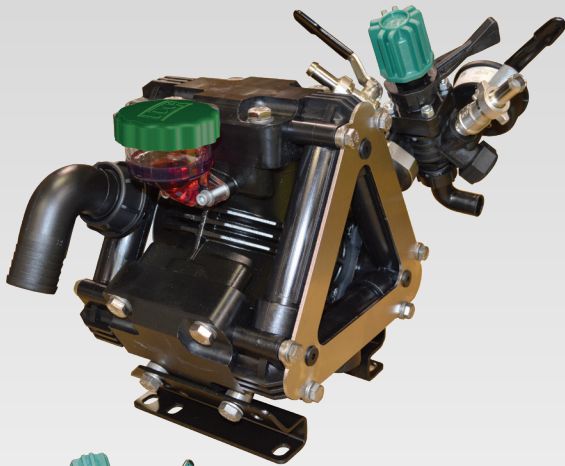

Scan this QR Code for more information



GREENTECH Diaphragms Standard. Buna-N Optional.

ZETA 40P & ZETA 85P low pressure 3-cylinder diaphragm pumps have poly heads, externally mounted manifolds and stainless-steel liquid handling parts and hardware components. A control valve with pressure gauge is standard on all models.

ZETA 40P & ZETA 85P pumps are excellent for the soft wash industry and other aggressive fluid applications.

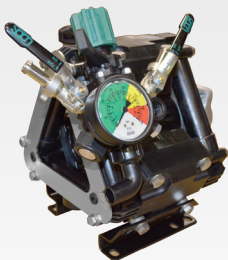

ZETA 40P VA

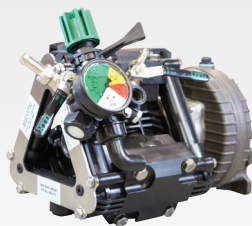

ZETA 40P VAGR3/4



ZETA-85P VA

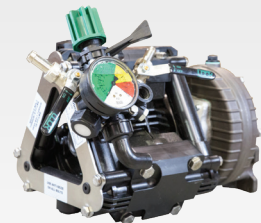

ZETA 85P VAGR3/4

Model	GPM	l/min	PSI	bar	RPM	Drive Configuration	Weight
ZETA 40P VA	10.5	44	300	20	550	Universal VA Drive Face.	29 LBS
ZETA 40P VAGR3/4	10.5	44	300	20	550	Gear Reduction for 3/4" Shaft Gas Engine, 4-6.5 HP	36 LBS
ZETA 85P VA	22.0	85	300	20	550	Universal VA Drive Face.	29 LBS
ZETA 85P VAGR3/4	22.0	85	300	20	550	Gear Reduction for 3/4" Shaft Gas Engine, 4-6.5 HP	36 LBS

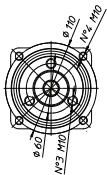
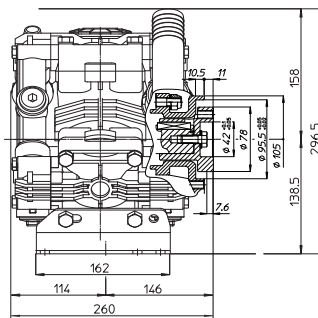
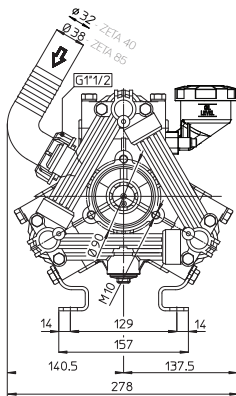

Dimensional Drawings are Shown in Millimeters. To Convert to Inches, Multiply Dimension x 0.03937

Specifications	ZETA 40P	ZETA 85P
Inlet Port	1-1/4" Hose Barb	1-1/2" Hose Barb
Outlet Ports - Valve	(2) 1/2" Hose Barb	(2) 1/2" Hose Barb
Bypass	3/4" Hose Barb	3/4" Hose Barb
Piston Diameter	55.0mm	60.0mm
Crankshaft Stroke/Code	11.0mm / J	18.0mm / A
Dims. - Pump Only		11"L x 11"W x 12"H
- GR Version		16"L x 11"W x 12"H

Lubrication: Requires 39 oz. of Udor Lube 40W Premium Pump Oil. Alternate Oil: 30W non-detergent or 15W-40 non-detergent oil.

QUICK REFERENCE SERVICE PARTS

Description	Part #
Diaphragm Kit - GREENTECH	6062.97
Diaphragm Bolt & Washer Kit	6062.48
Valve Kit	6062.H1
Regulator Repair Kit	6062.A9
Complete Repair Kit	8700.63CK

Recommended Accessories and Drive Options



6010.96
Control Unit
Regulator w/Gauge



5027.75
Gear Reduction
3/4" Shaft Gas Engines



7751.A3
1" Solid Keyed
Shaft and Bolts



UD1-1/4-16
1-1/4" HI-Flow Filter
16 Mesh Screen



UD1-1/2-16
1-1/2" HI-Flow Filter
16 Mesh Screen



15.5823
Udor Lube
Premium Pump Oil